

DOT 45 / DOT 45 AD ^{NEW}

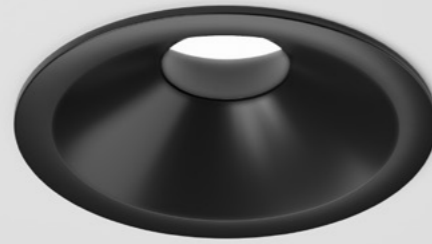

SPECIFICATIONS

base code	DOT 45 symmetrical or asymmetrical: 64050 - DOT 45 AD adjustable: 64071
typology	Glare free compact downlight with symmetrical or asymmetrical (downlight 25° and wallwasher) light distribution
mounting	In any material using springs (included)
diameter	45 mm / 1.8". Adjustable: 45 mm / 1.8"
height	Symmetrical: 41 mm / 1.6" (4W) - 46 mm / 1.8" (7W) Asymmetrical: 26 mm / 1" (4W) - 31 mm / 1.2" (7W) Adjustable: 55 mm / 2.2" (4W) - 60 mm / 2.4" (7W)
required depth	Symmetrical: 50 mm / 2". Asymmetrical: 35 mm / 1.4". Adjustable: 65 mm / 2.6"
ceiling cut out	42 mm / 1.65". Adjustable: 43 mm / 1.69"
construction	Fixture and flange: turning and milling aluminum. Reflector: polycarbonate complete with silicone gasket
finishes	Powder coated. Heat sink anodized
ingress protection	Symmetrical and adjustable: IP40 or IP65. North America damp or wet location. Asymmetrical: IP30. North America dry location
lamp type	LED array on printed circuit board. Remote power supply not included
lamp wattage	4W at 24V DC and 3W at 200 mA or 7W at 24V DC and 6W at 350 mA. North America 3W at 200 mA or 6W at 350 mA 24V DC: Min / max operating voltage: 20V - 30V
lamp lumens	4W: 330lm - 7W: 660lm
delivered lumens	4W: 135lm - 7W: 230lm. Asymmetrical 4W: 220lm - 7W: 340lm
lumen maintenance	50.000h L90
beam	16° (fixed or pre-tilted by 20°), 36°, 55°, 15°x45° or asymmetrical (downlight 25° and wallwasher). Inclination angle adjustable up to 25°
kelvin	2700K CRI93, 3000K CRI93 or 4000K CRI93 / 3 step MacAdam ellipse
special features	Protection against wrong connections - Two wires dimming. Thanks to the design of the reflector, the luminaire is totally glare free. The asymmetrical reflector offers longitudinal cut-off and delivers homogeneous light from the upper edge of the wall to the floor with no visible dark zones
dimming options	Push button, potentiometer, 0-10V, DALI, DMX, KNX. Dimming options depend on power supply and additional control units to be separately ordered as accessories
standards	CE, ETL listed for wet location



SYMMETRICAL

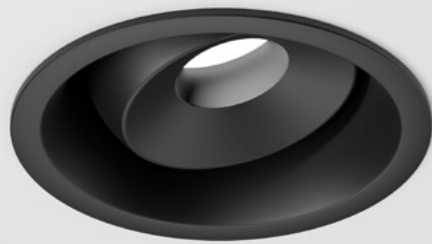

ADJUSTABLE

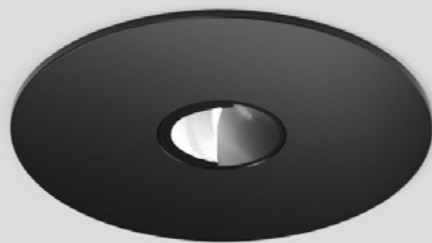

ASYMMETRICAL

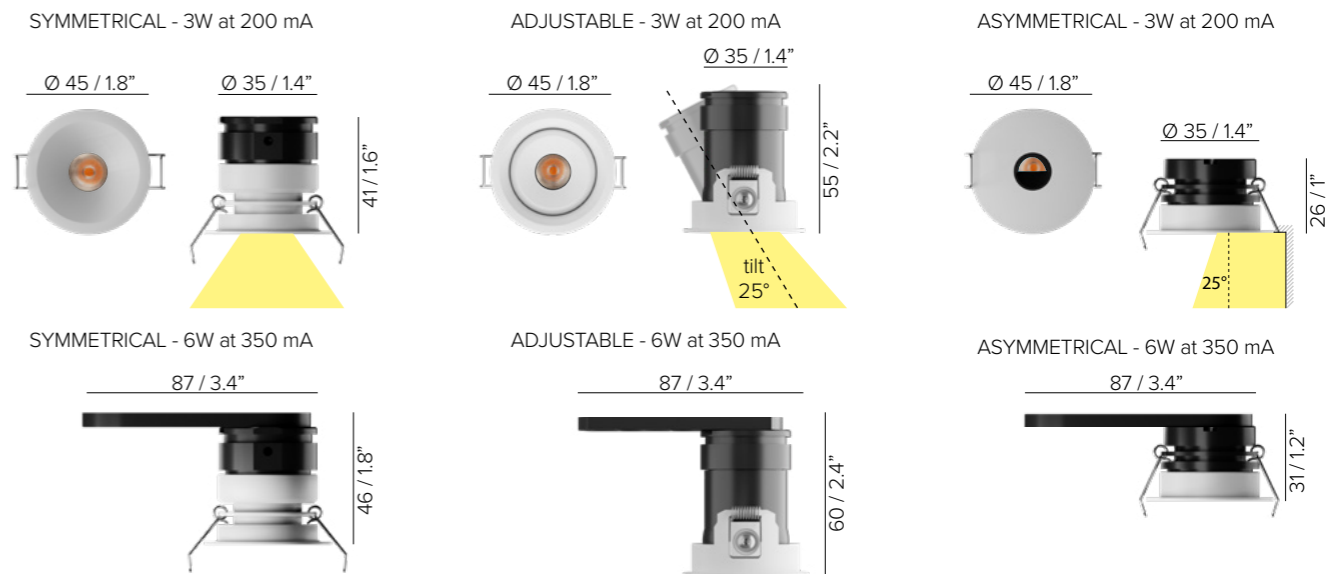

ASymm. SYMM. SYMM. SYMM. ASymm. AD SYMM. ASymm. AD 4W 7W

IP30 IP40 IP65 25° 50mm 2" 35mm 1.4" 65mm 2.6" 42mm 1.65" 0.09 kg 0.20 lbs 0.12 kg 0.26 lbs

CE ETL Intertek

AVAILABLE OPTIONS FOR DIFFERENT CEILING HEIGHTS



ATRIA X3 R
30W, 2440lm delivered

SEE PAGE 459



INSIDE 120 R
30W, 2440lm delivered

SEE PAGE 391

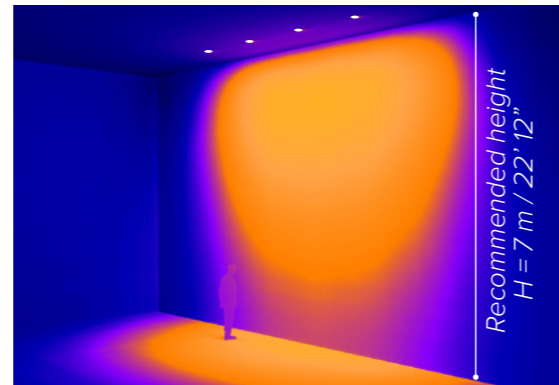

Recommended height
H = 7 m / 22' 12"



ATRIA X3 R
23W, 2025lm delivered

SEE PAGE 459



INSIDE 120 R
23W, 2025lm delivered

SEE PAGE 391

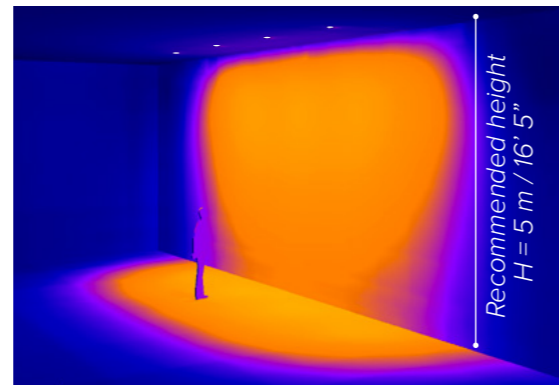

Recommended height
H = 5 m / 16' 5"



ATRIA XS R
10W, 870lm delivered

SEE PAGE 437



INSIDE 75 R
10W, 790lm delivered

SEE PAGE 381

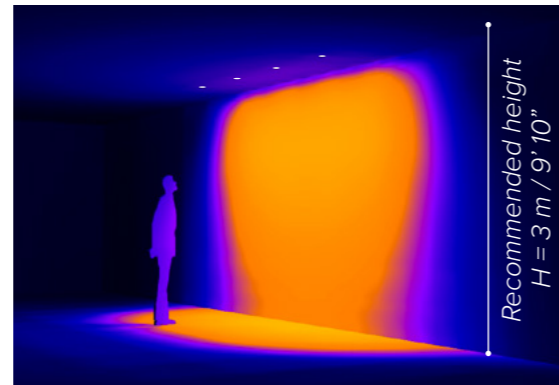

Recommended height
H = 3 m / 9' 10"



ATRIA 60 P
6W, 570lm delivered

SEE PAGE 431

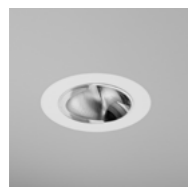

INSIDE 60 R
6W, 570lm delivered

SEE PAGE 375

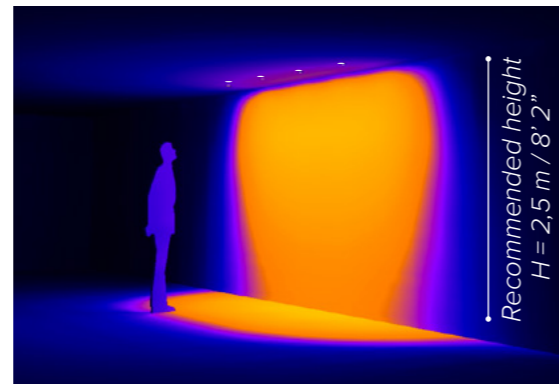

Recommended height
H = 2,5 m / 8' 2"

20lx 50lx 100lx 200lx

INSTALLATION GUIDE FOR THE ASYMMETRICAL DOWNLIGHT (DOWNLIGHT 25° AND WALLWASHER)

FOR A GOOD UNIFORMITY OF LIGHT ON THE WALL, FOLLOW THESE RULES:

1

The **distance from the wall (D)** shall be minimum H/5 and maximum H/3

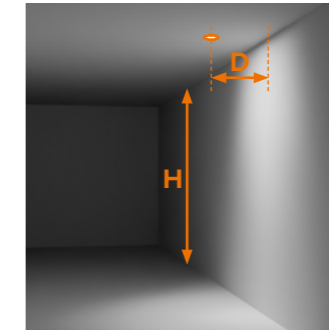

2

The **spacing between luminaires (S)** shall be minimum the distance (D) from the wall and maximum twice the distance (D x 2) from the wall

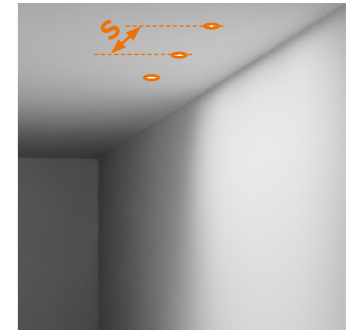

DOT 45
4W, 220lm delivered

H 2 m 6' 6"	D _{MIN} 0,4 m 1' 4"	S _{MIN} 0,4 m 1' 4"
		S _{MAX} 0,8 m 2' 7"
	D _{MAX} 0,7 m 2' 2"	S _{MIN} 0,7 m 2' 2"
		S _{MAX} 1,3 m 4' 3"



INSIDE 40 R
4W, 220lm delivered

SEE PAGE 367



DOT 30
1,5W, 40lm delivered

SEE PAGE 421

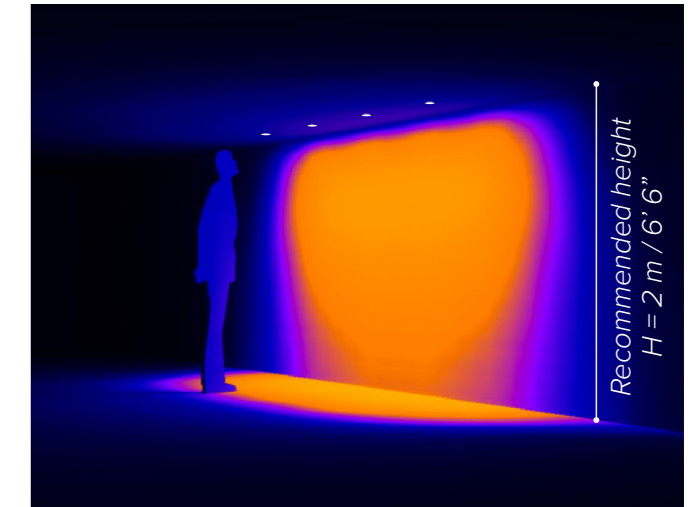

Recommended height
H = 2 m / 6' 6"

20lx 50lx 100lx 200lx

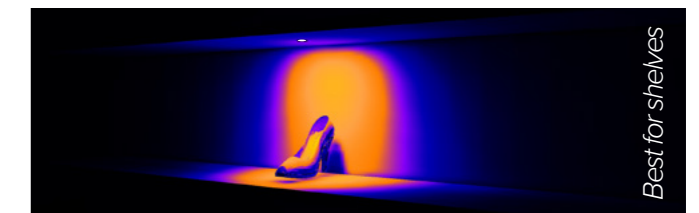

Best for shelves

Since every project is different, use this installation guide as a starting point for your lighting design. To further test the desired effect on your project, use the **photometric files** available on B LIGHT's website.

DOT 45 AD

ORDER CODE

BASE CODE **A . POWER SUPPLY** **B . KELVIN** **C . BEAM**

64071 **2** 24V DC power supply NOT included **U** listed 200/350 mA power supply NOT included

L 200/350 mA power supply NOT included

4 4000K CRI93 **5** 3000K CRI93 **8** 2700K CRI93

2 spot 16° **4** flood 36° **5** wide flood 55° **8** oval flood 15° x 45°

D . FINISHES **E . OTHER** **F . OUTPUT**

2 black RAL 9005 **B** IP40 **A** 4W (24V DC) 3W (200 mA)

6 white RAL 9003 **C** IP65 **B** 7W (24V DC) 6W (350 mA)

Example: **64071** **2** **5** **5** **2** **B** **A** = **64071-2552BA**



ASYMMETRICAL REFLECTORS (DOWNLIGHT 25° AND WALLWASHER)

DOT 45

ORDER CODE

BASE CODE **A . POWER SUPPLY** **B . KELVIN** **C . BEAM**

64050 **2** 24V DC power supply NOT included **U** listed 200/350 mA power supply NOT included

L 200/350 mA power supply NOT included

4 4000K CRI93 **5** 3000K CRI93 **8** 2700K CRI93

2 spot 16° **4** flood 36° **5** wide flood 55° **8** oval flood 15° x 45°

I spot 16° tilted by 20° **C** black asymmetrical

D . FINISHES **E . OTHER** **F . OUTPUT**

2 black RAL 9005 **asymmetrical** **A** 4W (24V DC) 3W (200 mA)

6 white RAL 9003 **symmetrical** **B** 7W (24V DC) 6W (350 mA)

A IP30 **B** IP40 **C** IP65

Example: **64050** **2** **5** **5** **2** **A** **A** = **64050-2552AA**

ACCESSORIES

REQUIRED ACCESSORIES - NOT INCLUDED

	code	output power	input voltage / frequency	IP	dimensions mm
Power supply 24V DC*, ON/OFF max No. fixtures	69041	18W / max 2	198-264V	50-60Hz	IP20 L124xW42xH30
	69054	60W / max 8	90-305V	47-63Hz	IP67 L162xW43xH32
Power supply 24V DC*, DALI max No. fixtures	69204	20W / max 2	99-264V	50-60Hz	IP20 L103xW67xH21
	69212	20W / max 2	99-264V	50-60Hz	IP20 L103xW67xH21
Power supply 24V DC*, 1-10V max No. fixtures	69121	ON/OFF, 8W / max 2	90-264V	50-60Hz	IP20 L115xW34xH19
	69122	1-10V, 10W / max 3	99-264V	50-60Hz	IP20 L111xW52xH22
	69123	DALI, 10W / max 3	198-264V	50-60Hz	IP20 L147xW44xH22
Power supply 350 mA max No. fixtures	69086	ON/OFF, 15W / max 2	90-264V	50-60Hz	IP20 L115xW34xH19
	69090	1-10V, 18W / max 2	99-264V	50-60Hz	IP20 L120xW52xH22
	69079	DALI, 17W / max 3	110-240V	50-60Hz	IP20 L120xW52xH22

Class 2 power supply 200/350 mA Consult **B LIGHT North America** Lighting Group Network
T: 212.775.6363
E: info@lightinggroupnetwork.com